

483 mm (19") Wall Mounting Cabinets IP55 - Outdoor



✓ 1.5 mm strong steel sheet

✓ Safety class IP 55

✓ Integrated air ventilation inlets

✓ Available with double wall structure

Abstract

483 mm (19") Wall Mounting Cabinets IP55 (Outdoor), 600 mm width - 450 mm, 600 mm depth

Features

- Safety class rating IP 55
- Lockable steel front door with pivot lever
- 140° door opening angle
- 3-point-locking-mechanism on the front door
- Front door with two welded, strengthening bars in U-shape as well as gasketing system
- 483 mm (19") profile rails mounted on the front side inside of the cabinet, galvanized
- 483 mm (19") profile rails are adjustable in depth and with height unit marking
- Load capacity of 483 mm (19") profile rails: 100 kg
- 1.5 mm strong sheet steel with a high loading capacity, powder coated
- Single welded housing for more strength
- Cable entries in base: 2x M32, 1x M63, 2x PVC blind cap (with diameter of 28 mm)
- Roof canopy offers protection for suitable fan units and takes care of deaeration and hot air
- Integrated air ventilation inlets ensure the entry of fresh air
- incl. 4 pcs. mounting brackets, 3 mm strong, as well as suitable screws and washers, for wall mounting
- available as version with double wall structure

Product Overview

The 483 mm (19") IP55 Outdoor Wall Mounting Cabinets are designed for industrial applications. They are based on the IP55 safety class which is conform to the EN 60529 and are therefore protected against water-and dirt ingress. The fan and filter components are based on safety class IP54. Best performance is provided e.g. via the 3-point-locking system with lockable swing handle and isolated cable entries. Integrated air ventilation inlets ensure the entry of fresh air (protection against water and dust acc. to IP54). Application areas are open areas which are under the effect of the environment (Rain, dust, sleet, snow, and splashing water).

An alternative version with double wall structure in the inside suits for a better protection against temperature fluctuations. Furthermore it can be used for easier mounting of e.g. cable management components.

Product Images



Double Wall Structure



Product Number Information - IP55 Wall Mounting Cabinets

Item code	Height unit (U)	Dimensions (HxWxD) in mm	Color	
DN-19 07U-I-OD	7U	490x600x450 mm	Grey (RAL 7035)	
DN-19 09U-I-OD	9U	579x600x450 mm		
DN-19 12U-I-OD	12U	713x600x450 mm		
DN-19 16U-I-OD	16U	891x600x450 mm		
DN-19-20U-I-OD	20U	1069x600x450 mm		
DN-19-22U-I-OD	22U	1157x600x450 mm		
DN-19-24U-I-OD	24U	1245x600x450 mm		
DN-19-26U-I-OD	26U	1334x600x450 mm		
DN-19 07U-6/6-I-OD	7U	490x600x600 mm		Grey (RAL 7035)
DN-19 09U-6/6-I-OD	9U	579x600x600 mm		
DN-19 12U-6/6-I-OD	12U	713x600x600 mm		
DN-19 16U-6/6-I-OD	16U	891x600x600 mm		
DN-19-20U-6-6-I-OD	20U	1069x600x600 mm		
DN-19-22U-6-6-I-OD	22U	1157x600x600 mm		
DN-19-24U-6-6-I-OD	24U	1245x600x600 mm		
DN-19-26U-6-6-I-OD	26U	1334x600x600 mm		

Logistic Information

Item code	Packaging dimensions (HxWxD) in mm	Net weight in kg	Gross weight in kg
DN-19 07U-I-OD	510x690x480 mm	31 kg	32 kg
DN-19 09U-I-OD	600x690x480 mm	33 kg	34 kg
DN-19 12U-I-OD	730x690x480 mm	37 kg	38 kg
DN-19 16U-I-OD	910x690x480 mm	41 kg	43 kg
DN-19-20U-I-OD	690x510x1120 mm	46 kg	48 kg
DN-19-22U-I-OD	690x510x1250 mm	51 kg	54 kg
DN-19-24U-I-OD	690x510x1360 mm	56 kg	61 kg
DN-19-26U-I-OD	690x510x1480 mm	61 kg	66 kg
DN-19 07U-6/6-I-OD	510x690x630 mm	37 kg	38 kg
DN-19 09U-6/6-I-OD	600x690x630 mm	40 kg	41 kg
DN-19 12U-6/6-I-OD	730x690x630 mm	43 kg	45 kg
DN-19 16U-6/6-I-OD	910x690x630 mm	49 kg	51 kg
DN-19-20U-6-6-I-OD	690x630x1120 mm	54 kg	58 kg
DN-19-22U-6-6-I-OD	690x630x1250 mm	59 kg	64 kg
DN-19-24U-6-6-I-OD	690x630x1360 mm	64 kg	70 kg
DN-19-26U-6-6-I-OD	690x630x1480 mm	70 kg	76 kg

Product Number Information - IP55 Wall Mounting Cabinets with double wall structure

Item code	Height unit (U)	Dimensions (HxWxD) in mm	Color
DN-19-07U-I-OD-2	7U	490x600x450 mm	Grey (RAL 7035)
DN-19-09U-I-OD-2	9U	579x600x450 mm	
DN-19-12U-I-OD-2	12U	713x600x450 mm	
DN-19-16U-I-OD-2	16U	891x600x450 mm	
DN-19-20U-I-OD-2	20U	1069x600x450 mm	
DN-19-22U-I-OD-2	22U	1157x600x450 mm	
DN-19-24U-I-OD-2	24U	1245x600x450 mm	
DN-19-26U-I-OD-2	26U	1334x600x450 mm	
DN-19-07U-6-6-I-OD-2	7U	490x600x600 mm	Grey (RAL 7035)
DN-19-09U-6-6-I-OD-2	9U	579x600x600 mm	
DN-19-12U-6-6-I-OD-2	12U	713x600x600 mm	
DN-19-16U-6-6-I-OD-2	16U	891x600x600 mm	
DN-19-20U-6-6-I-OD-2	20U	1069x600x600 mm	
DN-19-22U-6-6-I-OD-2	22U	1157x600x600 mm	
DN-19-24U-6-6-I-OD-2	24U	1245x600x600 mm	
DN-19-26U-6-6-I-OD-2	26U	1334x600x600 mm	

Logistic Information

Item code	Packaging dimensions (HxWxD) in mm	Net weight in kg	Gross weight in kg
DN-19-07U-I-OD-2	510x690x480 mm	32 kg	33 kg
DN-19-09U-I-OD-2	600x690x480 mm	34 kg	35 kg
DN-19-12U-I-OD-2	730x690x480 mm	38 kg	39 kg
DN-19-16U-I-OD-2	910x690x480 mm	42 kg	44 kg
DN-19-20U-I-OD-2	690x510x1120 mm	47 kg	49 kg
DN-19-22U-I-OD-2	690x510x1250 mm	52 kg	55 kg
DN-19-24U-I-OD-2	690x510x1360 mm	57 kg	62 kg
DN-19-26U-I-OD-2	690x510x1480 mm	62 kg	67 kg
DN-19-07U-6-6-I-OD-2	510x690x630 mm	38 kg	39 kg
DN-19-09U-6-6-I-OD-2	600x690x630 mm	41 kg	42 kg
DN-19-12U-6-6-I-OD-2	730x690x630 mm	44 kg	46 kg
DN-19-16U-6-6-I-OD-2	910x690x630 mm	50 kg	52 kg
DN-19-20U-6-6-I-OD-2	690x630x1120 mm	55 kg	59 kg
DN-19-22U-6-6-I-OD-2	690x630x1250 mm	60 kg	65 kg
DN-19-24U-6-6-I-OD-2	690x630x1360 mm	65 kg	71 kg
DN-19-26U-6-6-I-OD-2	690x630x1480 mm	71 kg	77 kg

Plinth

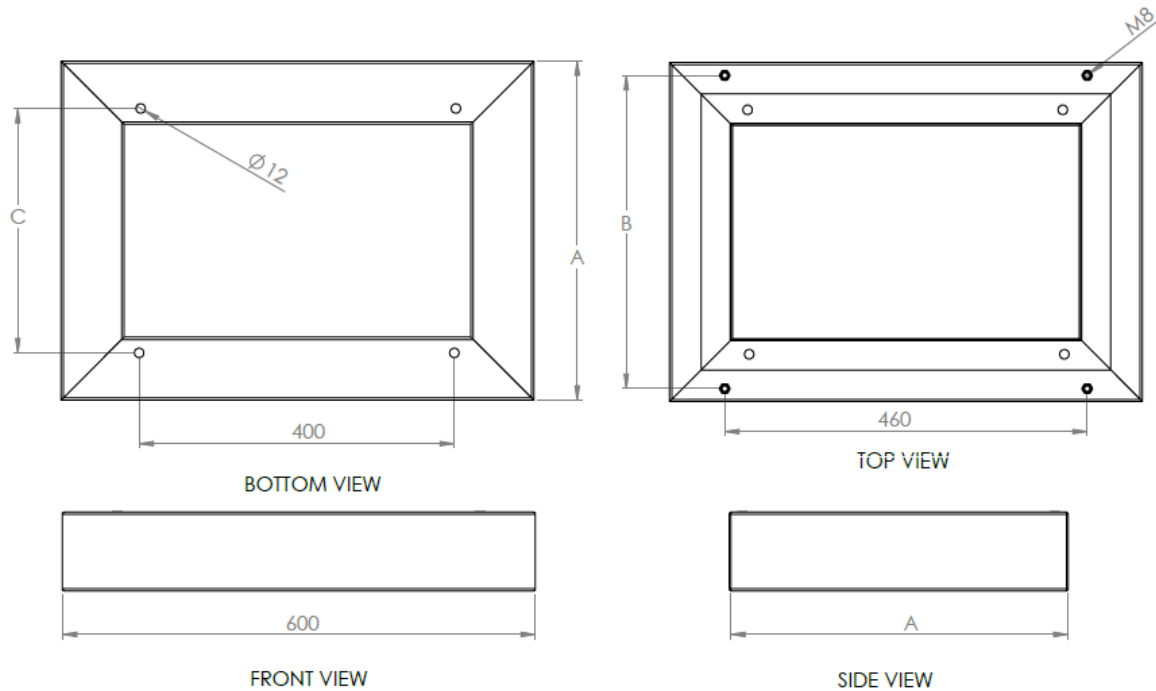

	A	B	C
450	427	397	310
600	577	547	460

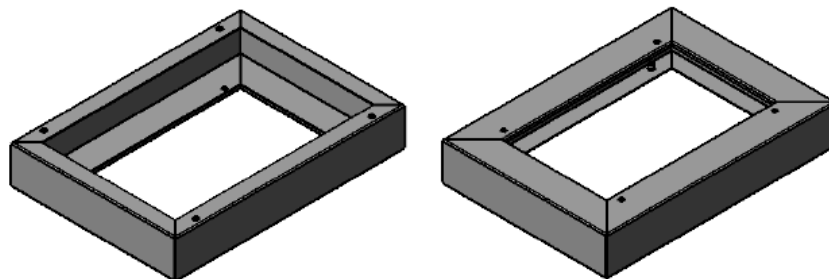

Product Number Information

Item code	Dimensions (HxWxD) in mm	Color
DN-19 PLINTH-45-I-OD	100x600x450 mm	Grey (RAL 7035)
DN-19 PLINTH-6-I-OD	100x600x600 mm	

Logistic Information

Item code	Packaging dimensions (HxWxD) in mm	Net weight / Gross weight in kg
DN-19 PLINTH-45-I-OD	100x600x450 mm	4.5 kg / 5.6 kg
DN-19 PLINTH-6-I-OD	100x600x600 mm	5.2 kg / 6.3 kg

Technical Drawings

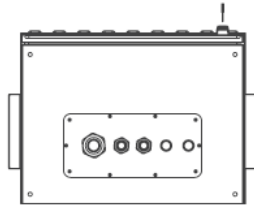

BOTTOM VIEW

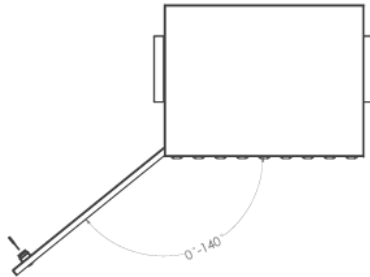

FRONT DOOR OPENING ANGLE

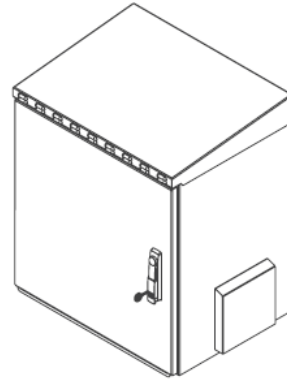

ISOMETRIC VIEW

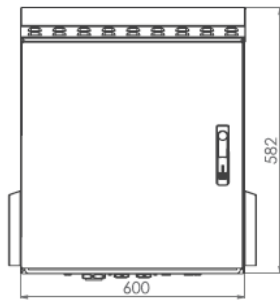

FRONT VIEW

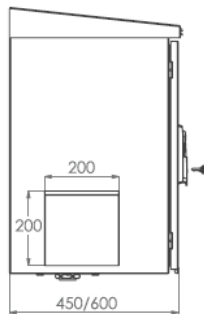

SIDE VIEW

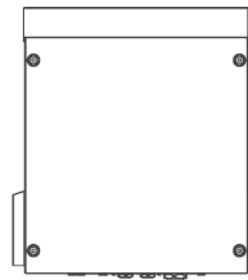

REAR VIEW

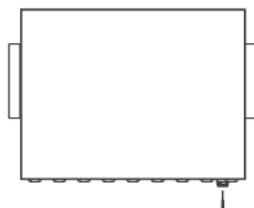

TOP VIEW

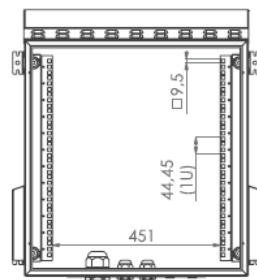

INSIDE VIEW

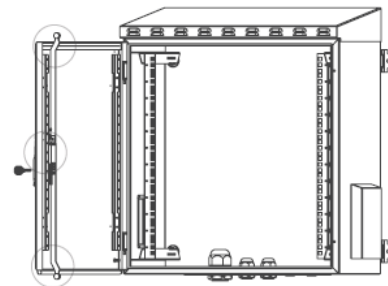

3 POINT LOCKING SYSTEM

Explosion View - IP55 Wall Mounting Cabinet with double wall structure

